

Data sheet | Item number: 2001-1204

2-conductor through terminal block; 1.5 mm²; for Ex e II and Ex i applications;
side and center marking; for DIN-rail 35 x 15 and 35 x 7.5; Push-in CAGE
CLAMP®; 1,50 mm²; blue

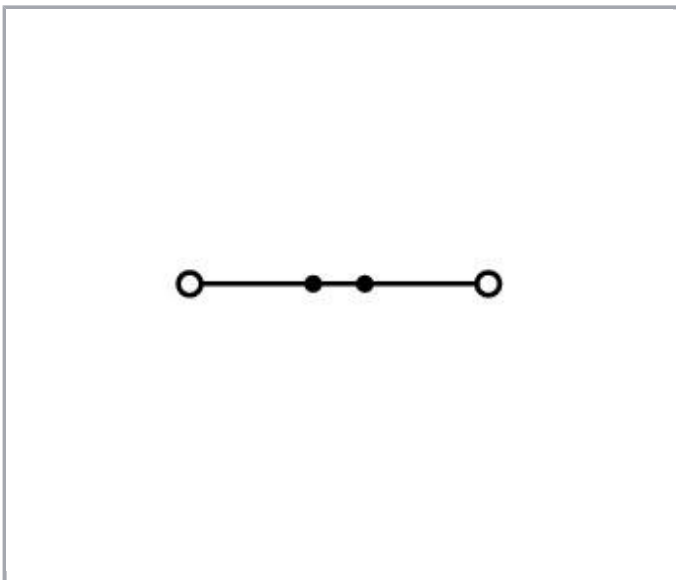

www.wago.com/2001-1204

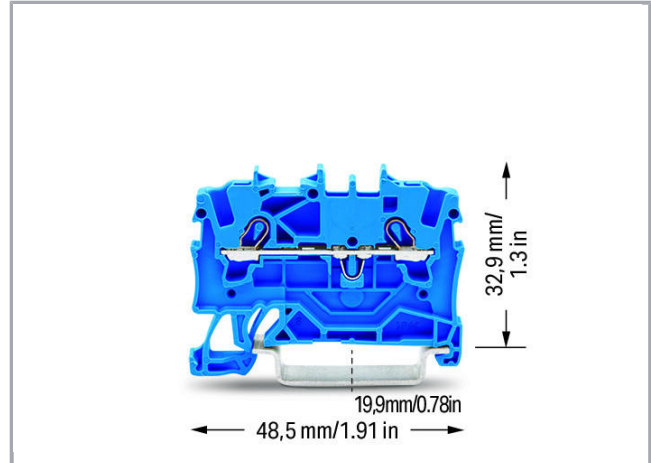
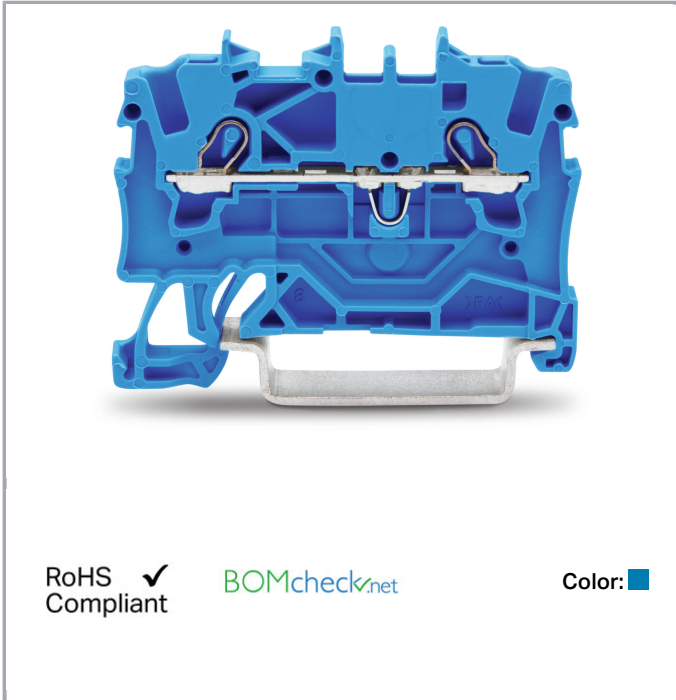

Data

Electrical data

Ratings per IEC/EN 60664-1

Rated voltage (III / 3)

800 V



Rated impulse voltage (III / 3)	8 kV
Rated current	18 A
Rated current (2)	24 A
Legend (ratings)	(III / 3) ≙ Overvoltage category III / Pollution degree 3

Approvals per UL 1059

Rated voltage UL (Use Group B)	600 V
Rated current UL (Use Group B)	15 A
Rated voltage UL (Use Group C)	600 V
Rated current UL (Use Group C)	15 A

Approvals per CSA

Rated voltage CSA (Use Group B)	600 V
Rated current CSA (Use Group B)	15 A
Rated voltage CSA (Use Group C)	600 V
Rated current CSA (Use Group C)	15 A

Approvals Ex

Rated voltage EN (Ex e II)	550 V
Rated current (Ex e II)	17 A
Rated current (Ex e II) with jumper	16 A

Connection data

Connection technology	Push-in CAGE CLAMP®
Actuation type	Push-in Open Tool Slot
Connectable conductor materials	Copper
Nominal cross section	1.5 mm ²
Solid conductor	0.25 ... 2.5 mm ² / 22 ... 14 AWG
Solid conductor, push-in termination	0.75 ... 2.5 mm ² / 18 ... 14 AWG
Fine-stranded conductor	0.25 ... 2.5 mm ² / 22 ... 14 AWG
Fine-stranded conductor with ferrule, push-in termination, from	0.75 mm ² / 18 AWG
Strip length	9 ... 11 mm / 0.35 ... 0.43 inch
Total number of connection points	2
Total number of potentials	1
Number of levels	1
Type of wiring	Front-entry wiring
Note (conductor cross-section)	Depending on the conductor characteristic, a conductor with a smaller cross section can also be inserted via push-in termination.
Number of jumper slots	2

Geometrical Data

Width	4.2 mm / 0.165 inch
Height from upper-edge of DIN-35 rail	32.9 mm / 1.295 inch
Depth	48.5 mm / 1.909 inch

Mechanical data

Design	horizontal
Type of mounting	DIN-35 rail
Marking level	Center/side marking

Material Data

Color	blue
Insulating material	Polyamide 66 (PA 66)
Fire load	0.074 MJ
Weight	4.4 g

Commercial data

Product Group	22 (TOPJOB S)
Packaging type	BOX
Country of origin	DE
GTIN	4017332997294
Customs Tariff No.	85369010000



Approvals / Certificates

Ex-Approvals



Logo	Approval	Additional Approval Text	Certificate name
	ATEX Physikalisch Technische Bundesanstalt (PTB)	EN 60079	PTB 05 ATEX 1094 U (II 2 G Ex e II bzw. I M 2 Ex e I)
	IECEX Physikalisch Technische Bundesanstalt (PTB)	IEC 60079	IECEX PTB 11.0093U (Ex e IIC Gb or Ex e I Mb)

Country specific Approvals

Logo	Approval	Additional Approval Text	Certificate name

	CCA DEKRA Certification B.V.	EN 60947	2160584.07
	CCA DEKRA Certification B.V.	EN 60947	NTR NL-7084
	CSA DEKRA Certification B.V.	C22.2 No. 158	1645434

Ship Approvals



















Logo	Approval	Additional Approval Text	Certificate name
	ABS American Bureau of Shipping	EN 60947	14-HG1293677-PDA
	DNV GL Det Norske Veritas, Germanischer Lloyd	-	TAE00001V2
	LR Lloyds Register	EN 60947	91/20112 (E9)

UL-Approvals

Logo	Approval	Additional Approval Text	Certificate name
	UL UL International Germany GmbH	UL 1059	20190731-E45172

Compatible products

End plate

	Item no.: 2002-1291 End and intermediate plate; 0.8 mm thick; gray	www.wago.com/2002-1291
	Item no.: 2002-1292 End and intermediate plate; 0.8 mm thick; orange	www.wago.com/2002-1292
	Item no.: 2002-1293 Separator plate; 2 mm thick; oversized; gray	www.wago.com/2002-1293
	Item no.: 2002-1294 Separator plate; 2 mm thick; oversized; orange	www.wago.com/2002-1294
	Item no.: 209-190 Separator for Ex e/Ex i applications; 3 mm thick; 90 mm wide; orange	www.wago.com/209-190
	Item no.: 209-191 Separator for Ex e/Ex i applications; 3 mm thick; 120 mm wide; orange	www.wago.com/209-191
check		
	Item no.: 2001-511 Modular TOPJOB®S connector; modular; for jumper contact slot; 1-pole; 1,50 mm ² ; gray	www.wago.com/2001-511
	Item no.: 2001-549 Spacer module; modular; e.g., for bridging commoned terminal blocks; gray	www.wago.com/2001-549
	Item no.: 2001-552 Modular TOPJOB®S connector; modular; for jumper contact slot; 2-pole; 1,50 mm ² ; gray	www.wago.com/2001-552
	Item no.: 2001-553 Modular TOPJOB®S connector; modular; for jumper contact slot; 3-pole; 1,50 mm ² ; gray	www.wago.com/2001-553
	Item no.: 2001-554 Modular TOPJOB®S connector; modular; for jumper contact slot; 4-pole; 1,50 mm ² ; gray	www.wago.com/2001-554
	Item no.: 2001-555 Modular TOPJOB®S connector; modular; for jumper contact slot; 5-pole; 1,50 mm ² ; gray	www.wago.com/2001-555
	Item no.: 2001-556 Modular TOPJOB®S connector; modular; for jumper contact slot; 6-pole; 1,50 mm ² ; gray	www.wago.com/2001-556
	Item no.: 2001-557 Modular TOPJOB®S connector; modular; for jumper contact slot; 7-pole; 1,50 mm ² ; gray	www.wago.com/2001-557
	Item no.: 2001-558 Modular TOPJOB®S connector; modular; for jumper contact slot; 8-pole; 1,50 mm ² ; gray	www.wago.com/2001-558
	Item no.: 2001-559 Modular TOPJOB®S connector; modular; for jumper contact slot; 9-pole; 1,50 mm ² ; gray	www.wago.com/2001-559
	Item no.: 2001-560 Modular TOPJOB®S connector; modular; for jumper contact slot; 10-pole; 1,50 mm ² ; gray	www.wago.com/2001-560
	Item no.: 2009-174 Test plug adapter; for 4 mm Ø test plugs; for testing TOPJOB®S rail-mounted terminal blocks; gray	www.wago.com/2009-174
	Item no.: 2009-182 Testing tap; for max. 2.5 mm ² ; tool-free connection for individual test wires 0.08 - 2.5 mm; gray	www.wago.com/2009-182

Insulation stop



Item no.: 2001-171
Insulation stop; 0.25 - 0.5 mm²; 5 pieces/strip; light gray

www.wago.com/2001-171

Jumper



Item no.: 2001-402
Push-in type jumper bar; insulated; 2-way; Nominal current 18 A; light gray

www.wago.com/2001-402



Item no.: 2001-403
Push-in type jumper bar; insulated; 3-way; Nominal current 18 A; light gray

www.wago.com/2001-403



Item no.: 2001-404
Push-in type jumper bar; insulated; 4-way; Nominal current 18 A; light gray

www.wago.com/2001-404



Item no.: 2001-405
Push-in type jumper bar; insulated; 5-way; Nominal current 18 A; light gray

www.wago.com/2001-405



Item no.: 2001-405/011-000
Star point jumper; insulated; 3-way (1-3-5); IN = IN terminal block; light gray

www.wago.com/2001-405/011-000



Item no.: 2001-406
Push-in type jumper bar; insulated; 6-way; Nominal current 18 A; light gray

www.wago.com/2001-406



Item no.: 2001-406/020-000
Delta jumper; insulated; 1-2 3-4 5-6; IN = IN terminal block; light gray

www.wago.com/2001-406/020-000



Item no.: 2001-407
Push-in type jumper bar; insulated; 7-way; Nominal current 18 A; light gray

www.wago.com/2001-407



Item no.: 2001-408
Push-in type jumper bar; insulated; 8-way; Nominal current 18 A; light gray

www.wago.com/2001-408



Item no.: 2001-409
Push-in type jumper bar; insulated; 9-way; Nominal current 18 A; light gray

www.wago.com/2001-409



Item no.: 2001-410
Push-in type jumper bar; insulated; 10-way; Nominal current 18 A; light gray

www.wago.com/2001-410



Item no.: 2001-433
Push-in type jumper bar; insulated; from 1 to 3; Nominal current 18 A; light gray

www.wago.com/2001-433



Item no.: 2001-434
Push-in type jumper bar; insulated; from 1 to 4; Nominal current 18 A; light gray

www.wago.com/2001-434



Item no.: 2001-435
Push-in type jumper bar; insulated; from 1 to 5; Nominal current 18 A; light gray

www.wago.com/2001-435



Item no.: 2001-436
Push-in type jumper bar; insulated; from 1 to 6; Nominal current 18 A; light gray

www.wago.com/2001-436



Item no.: 2001-437
Push-in type jumper bar; insulated; from 1 to 7; Nominal current 18 A; light gray

www.wago.com/2001-437

















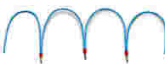

Item no.: 2001-438
Push-in type jumper bar; insulated; from 1 to 8; Nominal current 18 A; light gray

















www.wago.com/2001-438



Item no.: 2001-439
Push-in type jumper bar; insulated; from 1 to 9; Nominal current 18 A; light gray

www.wago.com/2001-439

	Item no.: 2001-440 Push-in type jumper bar; insulated; from 1 to 10; Nominal current 18 A; light gray	www.wago.com/2001-440
	Item no.: 2006-499 Step-down jumper; insulated; from 6/4 mm ² to 4/2.5/1.5 mm ² ; Nominal current 32 A; light gray	www.wago.com/2006-499
	Item no.: 2009-412 Push-in type wire jumper; insulated; wire length 60 mm; Conductor cross section 1.5 mm ² ; suitable for 2001, 2002, 2003 and 2022 Series rail-mounted terminal blocks; black	www.wago.com/2009-412
	Item no.: 2009-414 Push-in type wire jumper; insulated; wire length 110 mm; Conductor cross section 1.5 mm ² ; suitable for 2001, 2002, 2003 and 2022 Series rail-mounted terminal blocks; black	www.wago.com/2009-414
	Item no.: 2009-416 Push-in type wire jumper; insulated; wire length 250 mm; Conductor cross section 1.5 mm ² ; suitable for 2001, 2002, 2003 and 2022 Series rail-mounted terminal blocks; black	www.wago.com/2009-416
	Item no.: 210-103 Wire commoning chain; insulated; 50 connections; black	www.wago.com/210-103
	Item no.: 210-123 Wire commoning chain; insulated; 50 connections	www.wago.com/210-123
Protective Warning Marker		
	Item no.: 2001-115 Protective warning marker; with high-voltage symbol, black; for 5 terminal blocks; yellow	www.wago.com/2001-115
ferrule		
	Item no.: 216-241 Ferrule; Sleeve for 0.5 mm ² / 20 AWG; insulated; electro-tin plated; electrolytic copper; gastight crimped; acc. to DIN 46228, Part 4/09.90; white	www.wago.com/216-241
	Item no.: 216-242 Ferrule; Sleeve for 0.75 mm ² / 18 AWG; insulated; electro-tin plated; electrolytic copper; gastight crimped; acc. to DIN 46228, Part 4/09.90; gray	www.wago.com/216-242
	Item no.: 216-243 Ferrule; Sleeve for 1 mm ² / AWG 18; insulated; electro-tin plated; electrolytic copper; gastight crimped; acc. to DIN 46228, Part 4/09.90; red	www.wago.com/216-243
	Item no.: 216-244 Ferrule; Sleeve for 1.5 mm ² / AWG 16; insulated; electro-tin plated; electrolytic copper; gastight crimped; acc. to DIN 46228, Part 4/09.90; black	www.wago.com/216-244
Carrier rail		
	Item no.: 210-112 Steel carrier rail; 35 x 7.5 mm; 1 mm thick; 2 m long; slotted; according to EN 60715; "Hole width 25 mm	www.wago.com/210-112
	Item no.: 210-113 Steel carrier rail; 35 x 7.5 mm; 1 mm thick; 2 m long; unslotted; according to EN 60715	www.wago.com/210-113
	Item no.: 210-114 Steel carrier rail; 35 x 15 mm; 1.5 mm thick; 2 m long; unslotted; similar to EN 60715	www.wago.com/210-114
	Item no.: 210-115 Steel carrier rail; 35 x 7.5 mm; 1 mm thick; 2 m long; slotted; according to EN 60715; "Hole width 18 mm	www.wago.com/210-115
	Item no.: 210-118 Steel carrier rail; 35 x 15 mm; 2.3 mm thick; 2 m long; unslotted; according to EN 60715	www.wago.com/210-118
	Item no.: 210-196	

	Aluminum carrier rail; 35 x 8.2 mm; 1.6 mm thick; 2 m long; unslotted; similar to EN 60715; silver-colored	www.wago.com/210-196
	Item no.: 210-197 Steel carrier rail; 35 x 15 mm; 1.5 mm thick; 2 m long; slotted; similar to EN 60715	www.wago.com/210-197
	Item no.: 210-198 Copper carrier rail; 35 x 15 mm; 2.3 mm thick; 2 m long; unslotted; according to EN 60715; copper-colored	www.wago.com/210-198
Marking accessories		
	Item no.: 2009-110 Marking strips; on reel; not stretchable; plain; snap-on type; white	www.wago.com/2009-110
	Item no.: 2009-114 WMB-Inline; for Smart Printer; on reel; stretchable 4 - 4.2 mm; plain; snap-on type; white	www.wago.com/2009-114
	Item no.: 2009-114/000-002 WMB-Inline; for Smart Printer; on reel; stretchable 4 - 4.2 mm; plain; snap-on type; yellow	www.wago.com/2009-114/000-002
	Item no.: 2009-114/000-005 WMB-Inline; for Smart Printer; on reel; stretchable 4 - 4.2 mm; plain; snap-on type; red	www.wago.com/2009-114/000-005
	Item no.: 2009-114/000-006 WMB-Inline; for Smart Printer; on reel; stretchable 4 - 4.2 mm; plain; snap-on type; blue	www.wago.com/2009-114/000-006
	Item no.: 2009-114/000-007 WMB-Inline; for Smart Printer; on reel; stretchable 4 - 4.2 mm; plain; snap-on type; gray	www.wago.com/2009-114/000-007
	Item no.: 2009-114/000-012 WMB-Inline; for Smart Printer; on reel; stretchable 4 - 4.2 mm; plain; snap-on type; orange	www.wago.com/2009-114/000-012
	Item no.: 2009-114/000-023 WMB-Inline; for Smart Printer; on reel; stretchable 4 - 4.2 mm; plain; snap-on type; green	www.wago.com/2009-114/000-023
	Item no.: 2009-114/000-024 WMB-Inline; for Smart Printer; on reel; stretchable 4 - 4.2 mm; plain; snap-on type; violet	www.wago.com/2009-114/000-024
	Item no.: 793-4501 WMB marking card; as card; stretchable 4 - 4.2 mm; plain; snap-on type; white	www.wago.com/793-4501
	Item no.: 793-4501/000-002 WMB marking card; as card; stretchable 4 - 4.2 mm; plain; snap-on type; yellow	www.wago.com/793-4501/000-002
	Item no.: 793-4501/000-005 WMB marking card; as card; stretchable 4 - 4.2 mm; plain; snap-on type; red	www.wago.com/793-4501/000-005
	Item no.: 793-4501/000-006 WMB marking card; as card; stretchable 4 - 4.2 mm; plain; snap-on type; blue	www.wago.com/793-4501/000-006



Item no.: 793-4501/000-007
WMB marking card; as card; stretchable 4 - 4.2 mm; plain; snap-on type; gray

www.wago.com/793-4501/000-007



Item no.: 793-4501/000-012
WMB marking card; as card; stretchable 4 - 4.2 mm; plain; snap-on type; orange

www.wago.com/793-4501/000-012



Item no.: 793-4501/000-017
WMB marking card; as card; stretchable 4 - 4.2 mm; plain; snap-on type; light green

www.wago.com/793-4501/000-017



Item no.: 793-4501/000-023
WMB marking card; as card; stretchable 4 - 4.2 mm; plain; snap-on type; green

www.wago.com/793-4501/000-023



Item no.: 793-4501/000-024
WMB marking card; as card; stretchable 4 - 4.2 mm; plain; snap-on type; violet

www.wago.com/793-4501/000-024



Item no.: 793-501
WMB marking card; as card; not stretchable; plain; snap-on type; white

www.wago.com/793-501



Item no.: 793-501/000-002
WMB marking card; as card; not stretchable; plain; snap-on type; yellow

www.wago.com/793-501/000-002



Item no.: 793-501/000-005
WMB marking card; as card; not stretchable; plain; snap-on type; red

www.wago.com/793-501/000-005



Item no.: 793-501/000-006
WMB marking card; as card; not stretchable; plain; snap-on type; blue

www.wago.com/793-501/000-006



Item no.: 793-501/000-007
WMB marking card; as card; not stretchable; plain; snap-on type; gray

www.wago.com/793-501/000-007



Item no.: 793-501/000-012
WMB marking card; as card; not stretchable; plain; snap-on type; orange

www.wago.com/793-501/000-012



Item no.: 793-501/000-017
WMB marking card; as card; not stretchable; plain; snap-on type; light green

www.wago.com/793-501/000-017



Item no.: 793-501/000-023
WMB marking card; as card; not stretchable; plain; snap-on type; green

www.wago.com/793-501/000-023



Item no.: 793-501/000-024
WMB marking card; as card; not stretchable; plain; snap-on type; violet

www.wago.com/793-501/000-024

tools



Item no.: 210-647
Operating tool; Blade: 2.5 x 0.4 mm; with a partially insulated shaft

www.wago.com/210-647



Item no.: 210-648

Operating tool; Blade: 2.5 x 0.4 mm; with a partially insulated shaft; angled; short

www.wago.com/210-648



Item no.: 210-719

Operating tool; Blade: 2.5 x 0.4 mm; with a partially insulated shaft

www.wago.com/210-719

Downloads

Documentation

Bid Text

2001-1204 docx - Datei	02-Aug-2018	docx 15.0 kB	Download
---------------------------	-------------	-----------------	----------

2001-1204 X81 - Datei	19-Feb-2019	xml 4.1 kB	Download
--------------------------	-------------	---------------	----------

Additional Information

Technical explanations	03-Apr-2019	pdf 2.1 MB	Download
------------------------	-------------	---------------	----------

CAD/CAE-Data

CAD data

2D/3D Models 2001-1204	URL	Download
------------------------	-----	----------

CAE data

EPLAN Data Portal 2001-1204	Download
-----------------------------	----------

WSCAD Universe 2001-1204	Download
--------------------------	----------

Installation Notes

Inserting a conductor



All conductor types at a glance

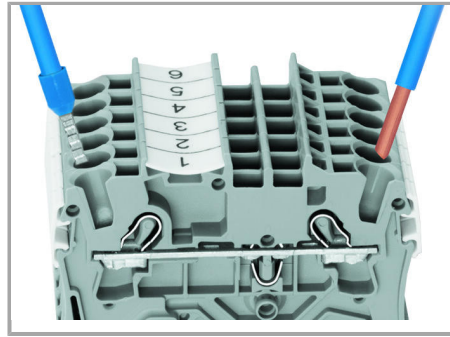

Terminating solid and ferruled conductors via push-in connection.

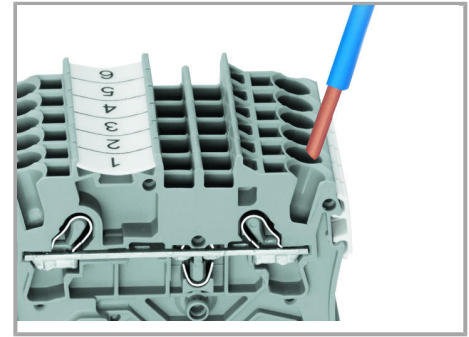

Inserting conductors via push-in termination.

Solid conductors with cross-sections from either one size above, or up to two sizes below, the rated cross-section can be simply pushed in – no tools needed.



Inserting a conductor via operating tool.

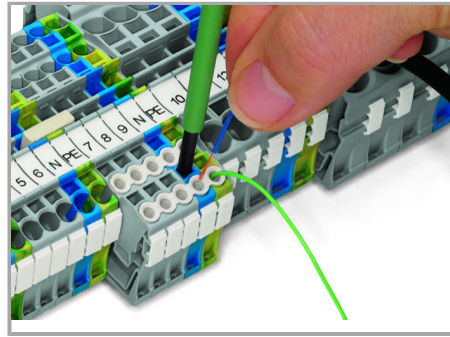

Conductor termination – Insulation stop.

Connecting fine-stranded conductors without ferrules, or small cross-sectional conductors that cannot be pushed in, is performed similarly to the original CAGE CLAMP® – just use an operating tool.

The smart feature:

To open the clamp, the operating tool is inserted vertically. The conductor entry is less than 15 degrees for easier wiring.

Jumpered



The push-in type jumper bar system is based on the common plug and socket principle. Each terminal block is spring-loaded with a double socket and a resilient CrNi steel spring. The jumper contact material is pure electrolytic copper, which allows for an extremely small design capable of carrying the full-rated current of the terminal block. Ground terminal blocks can also be commoned using the same jumper system. Custom jumpers are created by breaking and removing jumper contacts (2000, 2001, 2002, 2004 Series).

Removing a push-in type jumper bar.

Insert the operating tool between the jumper and the partition wall of the dual jumper slots, then lift up the jumper.

Place the operating tool in the center of jumpers up to five contacts (see above), or alternately on both sides for jumpers with more than five contacts.

Jumpered



This star point jumper has been specially developed to create a "star point" and is used on motor terminal boards equipped with TOPJOB® S rail-mount terminal blocks.

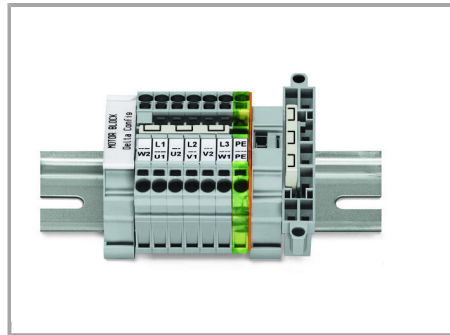

This delta jumper has been specially developed to create a delta configuration and is used on motor terminal boards equipped with TOPJOB® S rail-mount terminal blocks.

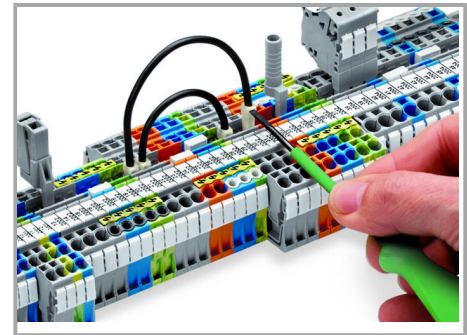

Push down the wire jumper until fully inserted. Lift the jumper with an operating tool for rewiring.

Jumpered

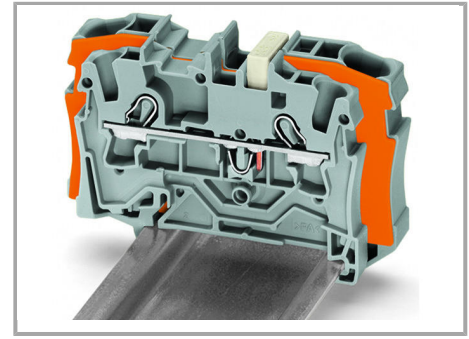
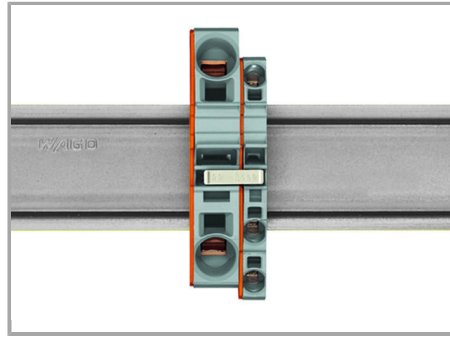
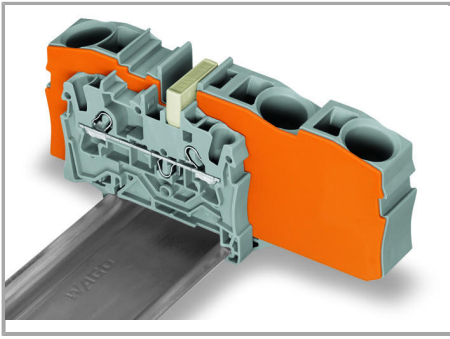

Step-down jumpers may common terminal blocks of different sizes, without losing a conductor clamping point. This can be beneficial on long conductor runs where voltage drops may be problematic. A large conductor can be easily connected to smaller conductors at the distribution point.

Using step-down jumpers, an end plate must be inserted between the terminal blocks to be commoned.

Step-down jumper (2006-499) commons 6 /4 mm² (10/12 AWG) terminal blocks (2006 /2004 Series) with 4/2.5/1.5 mm² (12/14/16 AWG) terminal blocks (2004/2002/2001 Series).

Commoning may be made in either direction using the special thin end plate to cover the open side. Additional through terminal blocks having a smaller cross-section may be commoned using push-in type jumper bars.

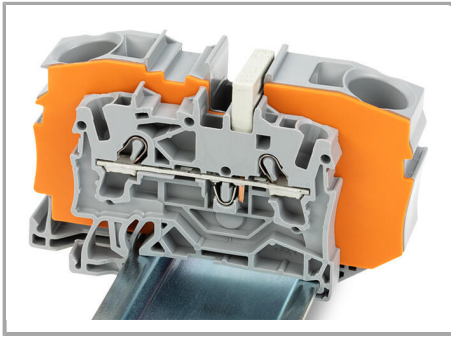

Step-down jumper (2016-499) commons 16 /10 mm² (16/8 AWG) terminal blocks (2016 /2010 Series) with 10/6/4/2.5 mm² (8/10/12 /14 AWG) terminal blocks (2010/2006/2004 /2002 Series).

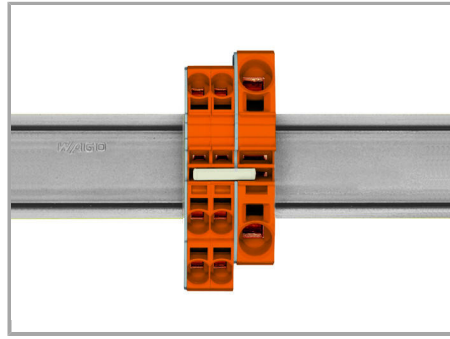

Stepping down via push-in type jumper bar.

Commoning via open terminal side with end plate allows jumpering over two cross-section sizes for 16 mm² (6 AWG) and 10 mm² (8 AWG) and one cross-section size for 6/4/2.5 mm² (10/12/14 AWG). An example: from 16 mm² (6 AWG) to 6 mm² (10 AWG) (see illustration above) or from 10 mm² (8 AWG) to 4 mm² (12 AWG).

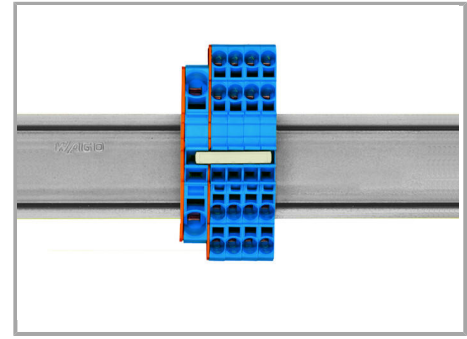

Stepping down via push-in type jumper bar.

Commoning via closed terminal side with end plate allows jumpering over two cross-section sizes, e.g., from 16 mm² (6 AWG) to 6 mm² (10 AWG) or from 6 mm² (10 AWG) to 2.5 mm² (14 AWG) (see illustration above).

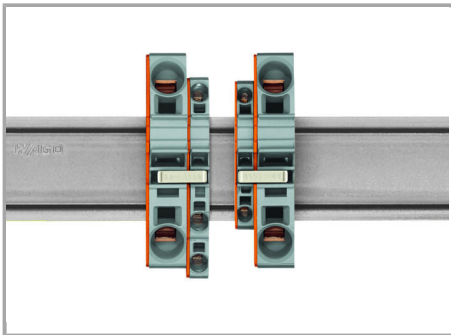

Note:

The total current of the outgoing circuits shall not exceed the nominal current of the step-down jumper/push-in type jumper bar.

Testing

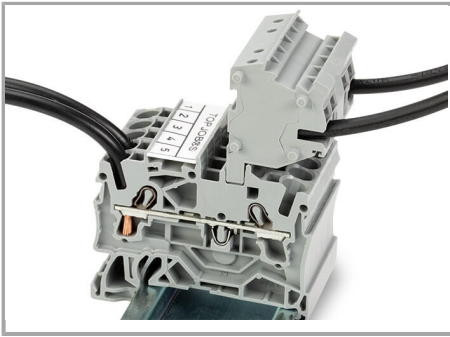

The modular TOPJOB® S connectors also connect conductors of the same size as the terminal blocks being used.

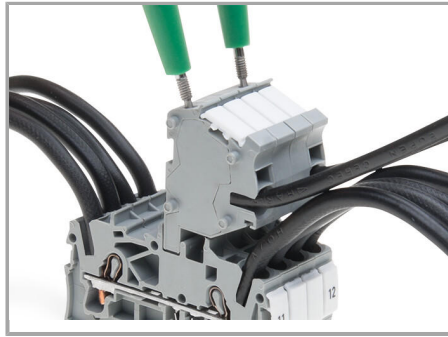

TOPJOB® S Connectors with a 2 mm Ø test socket for testing voltage via 2-pole voltage tester

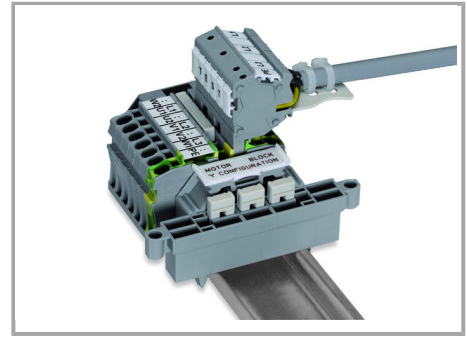

Rail-mount terminal block assembly for electric motor wiring

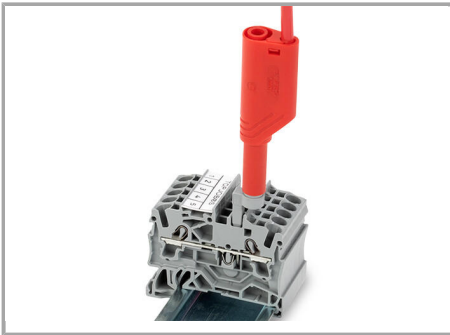

Test plug adapter (2009-174, CAT II) for 4 mm Ø plugs – compatible with 2000 to 2016 Series

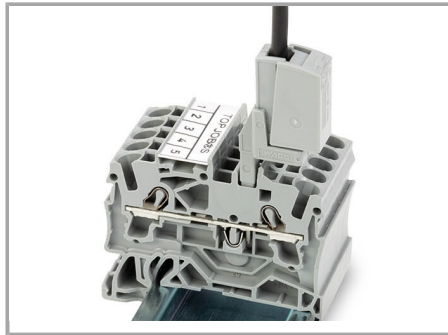

Testing tap (2009-182) for tool-free connection of test cables up to 2.5 mm² (12 AWG) – compatible with 2000 to 2016 Series

Marking

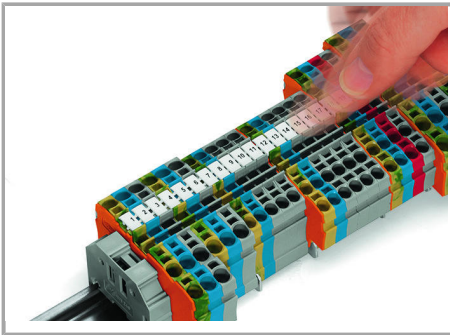

Snapping WMB Inline markers into marker slots.

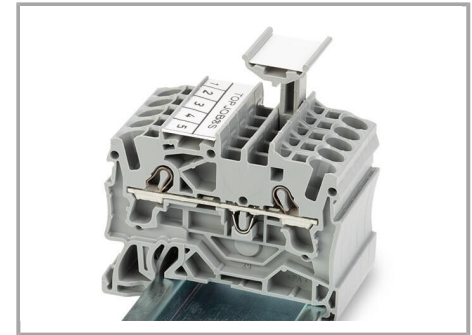
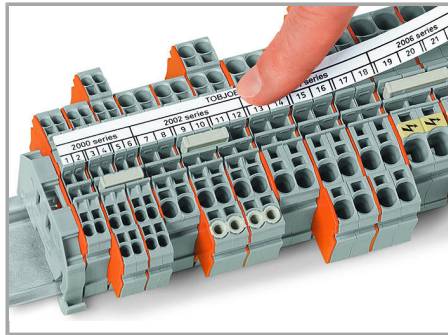

TOPJOB® S 2009-193 Group Marker Carrier (equipped with a marking strip) for all 2001 to 2016 Series TOPJOB® S Rail-Mount Terminal Blocks

Do not use on an end plate!

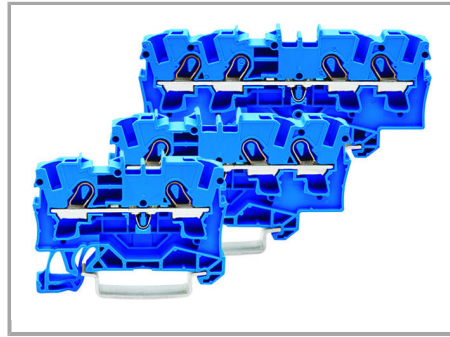
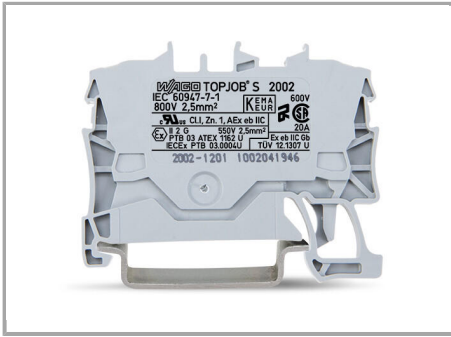

Through terminal blocks with a blue insulated housing are suitable for Ex i applications.

All through and ground conductor terminal blocks are suitable for Ex e II applications.

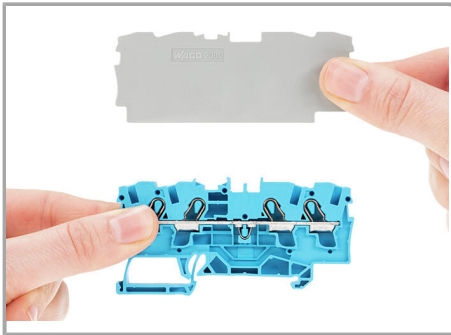

Separator for Ex e/Ex applications

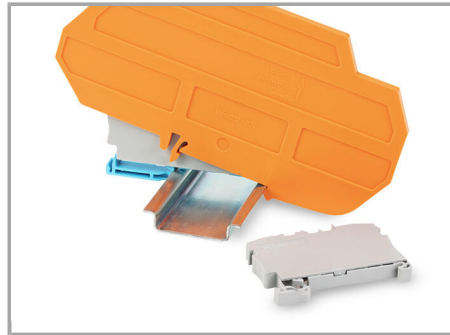

Ex e II/Ex i terminal strip

An end plate must be applied to the terminal block located directly behind an Ex e/Ex i separator plate.

Notice:

The movable feet of terminal blocks and separator plates must face the same direction.

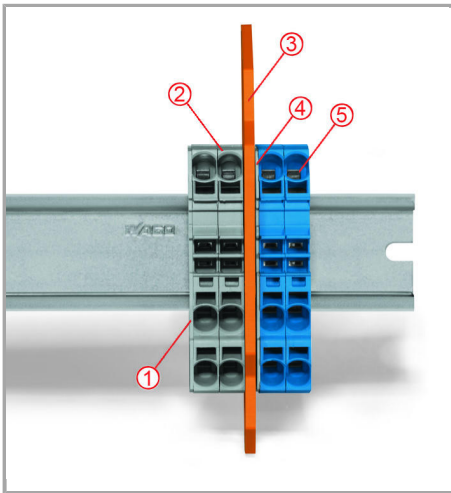

Separator located between Ex e II and Ex i terminal strip

End plate

Ex e II terminal blocks

Separator for Ex e/Ex i applications

End plate

Ex i terminal blocks

According to EN 50020, a minimum distance of 50 mm must be kept between live parts of Ex e and Ex i circuits. The use of Ex e/Ex i separators is a space-saving solution when Ex e and Ex i terminal blocks are mounted on a common carrier rail.

Product family

TOPJOB® S

TOPJOB® S: In various industrial applications and modern building installations, WAGO's wide and versatile range of rail-mount terminal blocks provides more than just reliable electrical connections.

[Show all products from the family](#)



Subject to changes.

WAGO Kontakttechnik GmbH & Co. KG
Hansastr. 27
32423 Minden
Phone: +49571 887-0 | Fax: +49571 887-169
Email: info.de@wago.com | Web: www.wago.com

Do you have any questions about our products?
We are always happy to take your call at +49 (571) 887-44222.