

Fișă tehnică | Număr articol: 221-500

Mounting carrier; 221 Series - 4 mm²; for DIN-35 rail mounting/screw mounting; orange

www.wago.com/221-500

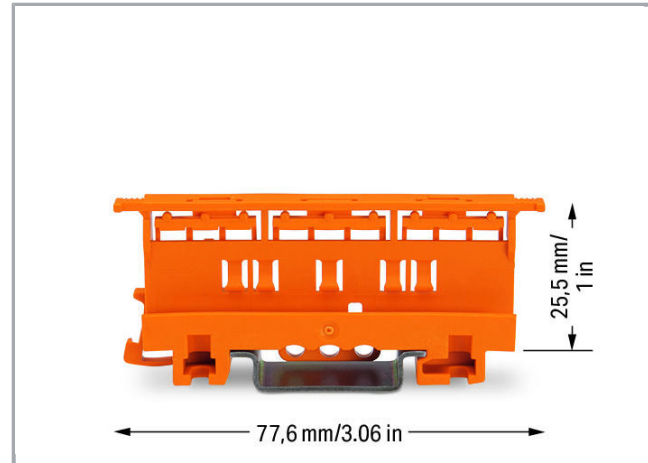
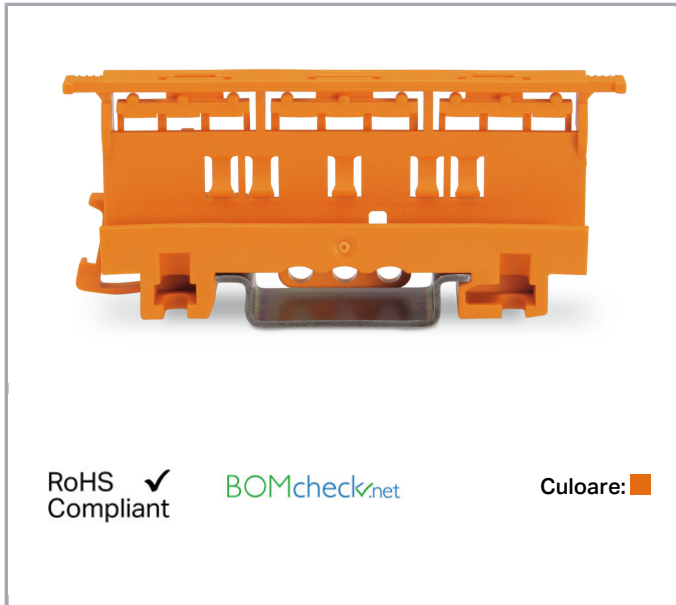

Date

Geometrical Data

Width	17,5 mm / 0.689 inch
Height from upper-edge of DIN-rail	25,5 mm / 1.004 inch
Depth	77,6 mm / 3.055 inch

Material Data

Color	orange
Insulation material	Polyamide 66 (PA 66)
Flammability class per UL94	V0
Weight	9,6 g

Commercial data

Packaging type	BOX
Country of origin	CN
GTIN	4055143421942
Customs tariff number	39269097900

Supus modificărilor.

WAGO Kontakttechnik GmbH & Co. KG
/Representative Office Romania
Sos. Pipera-Tunari nr. 1/1
building 1, 2nd floor | 077190 Voluntari, Ilfov
Tel.: +40-(0)31 421 85 68 | Email: info-RO@wago.com

Aveți întrebări despre produsele noastre?
Vă stăm la dispoziție pentru preluarea apelului la +40 (0) 31 421 85 68.

Counterpart

Produse compatibile

Marking accessories

Nr. articol: 210-833

Marking strips; on reel; 6 mm wide; plain; Self-adhesive; white

www.wago.com/210-833

Mounting adapter



Nr. articol: 222-505

Strain relief plate; for mounting carrier; 221 or 222 Series, can be snapped

www.wago.com/222-505



Nr. articol: 222-510

Angled DIN-rail adapter; in combination with mounting carrier; 221-500 or 222-500; for DIN-35 rail mounting; gray

www.wago.com/222-510

Descărcări

Documentation

Additional Information

Technical explanations

03.04.2019

pdf
2,1 MB

Descărcare

CAD/CAE-Data

CAD data

2D/3D Models 221-500

URL

Descărcare

CAE data

EPLAN Data Portal 221-500

URL

Descărcare

Installation Notes

Inserting a conductor

Supus modificărilor.

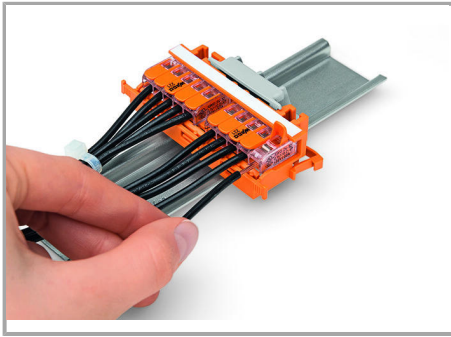

CAGE CLAMP® connection:

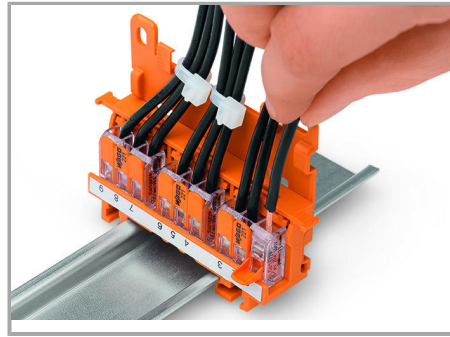

Removing a conductor.

Conductor termination with connectors fitted in a mounting carrier

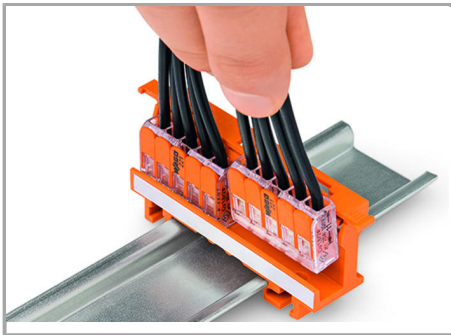

Inserting a connector into the mounting carrier.

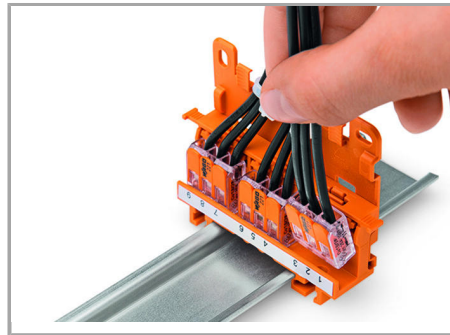

Inserting a connector into the mounting carrier.

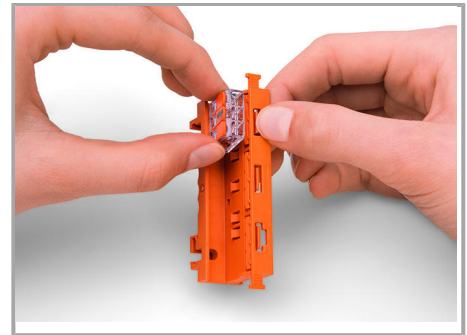

Removing a connector from the mounting carrier.

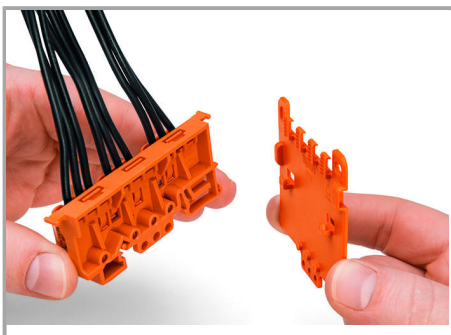

Securing a strain relief plate (222-505) to the mounting carrier.

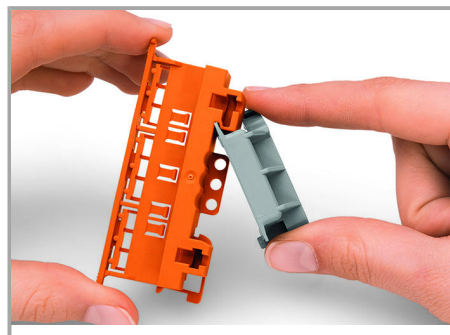

Snapping the angled DIN-rail adapter (222-510) onto the mounting carrier.

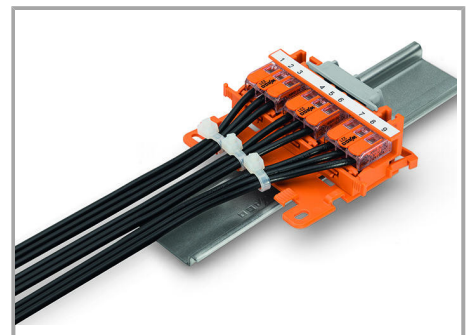

Horizontal mounting on DIN-35 rail using an angled DIN-rail adapter.

Supus modificărilor.

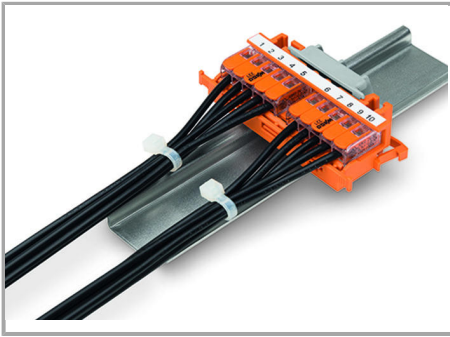

Horizontal mounting on DIN-35 rail using an angled DIN-rail adapter.

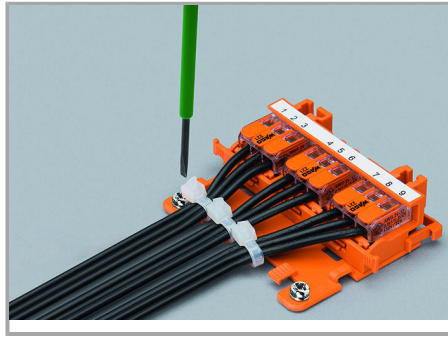

Horizontal screw mounting with strain relief plate on a flat surface

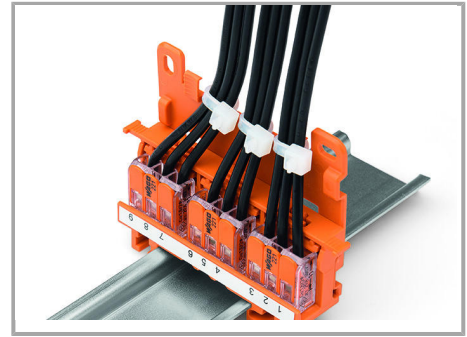

Vertical mounting with strain relief plate on DIN-35 rail.

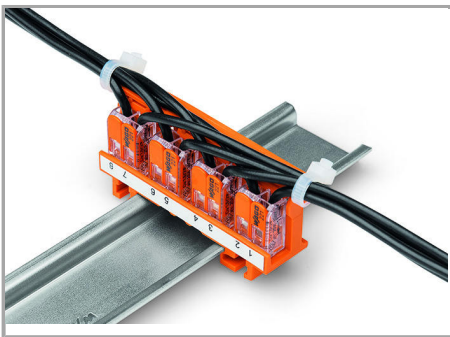

Strain relief via cable ties on the mounting carrier (transverse to the connectors' wiring direction) – clamping units labeled via marking strips (210-334).

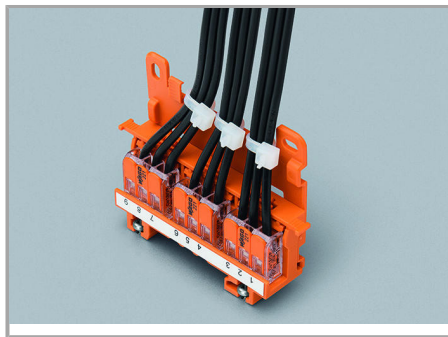

Vertical screw mounting with strain relief plate on a flat surface.

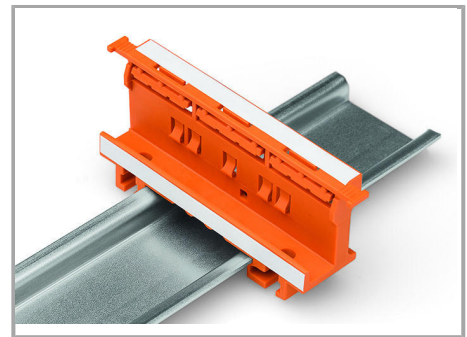

Mounting carrier on a DIN-35 rail

Testing

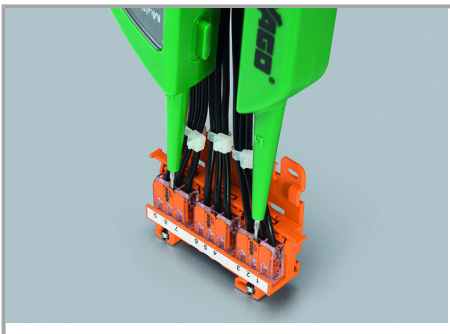

Testing connectors via test slots on top of the carrier.

Supus modificărilor.