

## Fișă tehnică | Număr articol: 221-615

COMPACT Splicing Connector; for all conductor types; max. 6 mm<sup>2</sup>; 5-conductor; with levers; transparent housing; Surrounding air temperature: max 85°C (T85); 6,00 mm<sup>2</sup>; transparent

[www.wago.com/221-615](http://www.wago.com/221-615)

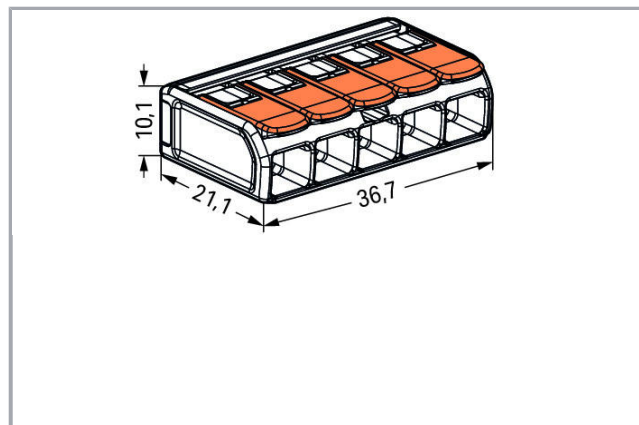
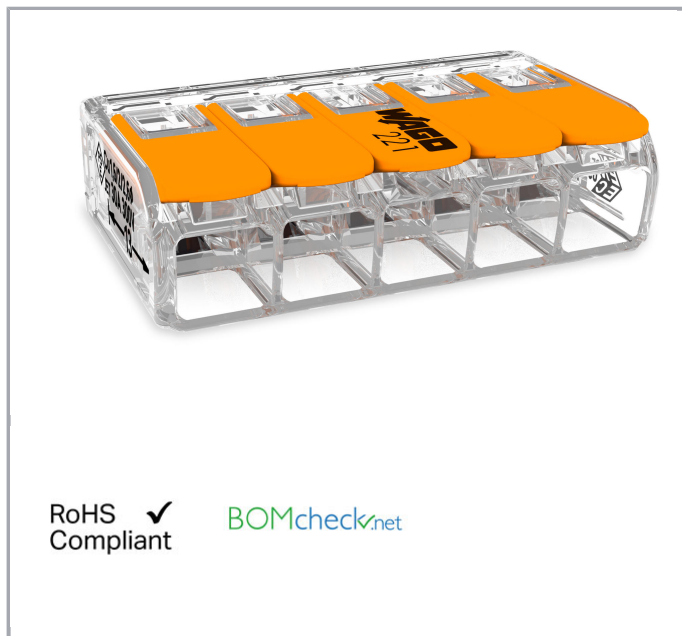

RoHS  Compliant

[BOMcheck.net](https://www.bomcheck.net)



### Descriere articol

Your Benefits:

- Easy to use: Pull the lever up, insert a conductor and push the lever back down
- Available as 2-, 3- and 5-wire connectors
- Easily terminate conductors for all conductors from 0.5 to 6 mm<sup>2</sup> (20 ... 10 AWG).

Supus modificărilor.

WAGO Kontakttechnik GmbH & Co. KG  
/Representative Office Romania  
Sos. Pipera-Tunari nr. 1/1  
building 1, 2nd floor | 077190 Voluntari, Ilfov  
Tel.: +40-(0)31 421 85 68 | Email: [info-RO@wago.com](mailto:info-RO@wago.com)

Aveți întrebări despre produsele noastre?  
Vă stăm la dispoziție pentru preluarea apelului la +40 (0) 31 421 85 68.



- Time savings for installers and device manufacturers.
- Quickly install devices with higher levels of power consumption.
- Safely install long cable runs with larger conductor cross sections.
- Mounting carrier for installation conforming to standards
- Custom carriers are possible

**Safety information 1:**

In grounded power lines

**Date****Electrical data****Ratings per IEC/EN 60664-1**

Rated voltage (II / 2)	450 V
Rated impulse voltage (II / 2)	4 kV
Rated current	41 A
Legend (ratings)	(II / 2) $\triangleq$ Overvoltage category II / Pollution degree 2

**Approvals per UL 1059**

Rated voltage UL (Use Group C)	600 V
Rated current UL (Use Group C)	30 A
Approvals per	UL 486C

**Connection data**

Connection technology	CAGE CLAMP®
Actuation type	Lever
Connectable conductor materials	Copper
Nominal cross section	6 mm <sup>2</sup>
Solid conductor	0.5 ... 6 mm <sup>2</sup> / 20 ... 10 AWG
Stranded conductor	0.5 ... 6 mm <sup>2</sup> / 20 ... 10 AWG
Fine-stranded conductor	0.5 ... 6 mm <sup>2</sup> / 20 ... 10 AWG
Strip length	12 ... 14 mm / 0.47 ... 0.55 inch
Total number of connection points	5
Total number of potentials	1
Type of wiring	Side-entry wiring

Supus modificărilor.

WAGO Kontakttechnik GmbH & Co. KG  
 /Representative Office Romania  
 Sos. Pipera-Tunari nr. 1/1  
 building 1, 2nd floor | 077190 Voluntari, Ilfov  
 Tel.: +40-(0)31 421 85 68 | Email: info-RO@wago.com

Aveți întrebări despre produsele noastre?  
 Vă stăm la dispoziție pentru preluarea apelului la +40 (0) 31 421 85 68.

## Geometrical Data

Width	36.7 mm / 1.445 inch
Height	10.1 mm / 0.398 inch
Depth	21.1 mm / 0.831 inch

## Material Data

Color	transparent
Flammability class per UL94	V2
Weight	7,1 g

## Environmental Requirements

Surrounding air (operating) temperature	85 °C
Continuous operating temperature	105 °C
T-Marking per EN 60998	T85

## Commercial data

Packaging type	BOX
Country of origin	CH
GTIN	4055143715478
Customs Tariff No.	85369010000

## Aprobări / certificate

### Ship Approvals



Emblemă	Aprobare	Text de aprobare suplimentar	Nume certificat
	<b>ABS</b> American Bureau of Shipping	EN 60998	18- HG1755093- PDA
	<b>DNV GL</b> Det Norske Veritas, Germanischer Lloyd	EN 60998	TAE000015T
	<b>LR</b> Lloyds Register	EN 60998	04/20013 (E8)

Supus modificărilor.

WAGO Kontakttechnik GmbH & Co. KG  
/Representative Office Romania  
Sos. Pipera-Tunari nr. 1/1  
building 1, 2nd floor | 077190 Voluntari, Ilfov  
Tel.: +40-(0)31 421 85 68 | Email: info-RO@wago.com

Aveți întrebări despre produsele noastre?  
Vă stăm la dispoziție pentru preluarea apelului la +40 (0) 31 421 85 68.

## UL-Approvals

Emblemă	Aprobare	Text de aprobare suplimentar	Nume certificat
	UL Underwriters Laboratories Inc.	UL 467	E201573
	UL Underwriters Laboratories Inc.	UL 486C	E69654

## Produse compatibile

## Mounting adapter

Nr. articol: 221-510 Mounting carrier; 221 Series - 6 mm <sup>2</sup> ; for DIN-35 rail mounting/screw mounting; orange	<a href="http://www.wago.com/221-510">www.wago.com/221-510</a>
Nr. articol: 221-510/000-006 Mounting carrier; 221 Series - 6 mm <sup>2</sup> ; for DIN-35 rail mounting/screw mounting; blue	<a href="http://www.wago.com/221-510/000-006">www.wago.com/221-510/000-006</a>
Nr. articol: 221-510/000-053 Mounting carrier; 221 Series - 6 mm <sup>2</sup> ; for DIN-35 rail mounting/screw mounting; dark gray-yellow	<a href="http://www.wago.com/221-510/000-053">www.wago.com/221-510/000-053</a>

## Descărcări

## Documentation

## Additional Information

Technical explanations	Apr 3, 2019	pdf 2,1 MB	Descărcare
------------------------	-------------	---------------	------------

## CAD/CAE-Data

## CAD data

2D/3D Models 221-615	URL	Descărcare
----------------------	-----	------------

## Installation Notes

Supus modificărilor.

WAGO Kontakttechnik GmbH & Co. KG  
/Representative Office Romania  
Sos. Pipera-Tunari nr. 1/1  
building 1, 2nd floor | 077190 Voluntari, Ilfov  
Tel.: +40-(0)31 421 85 68 | Email: info-RO@wago.com

Aveți întrebări despre produsele noastre?  
Vă stăm la dispoziție pentru preluarea apelului la +40 (0) 31 421 85 68.

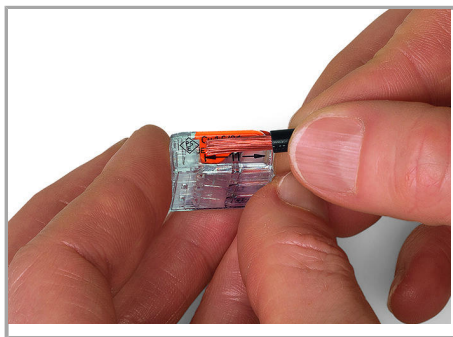

Strip conductor to 11 mm (0.43 inch).

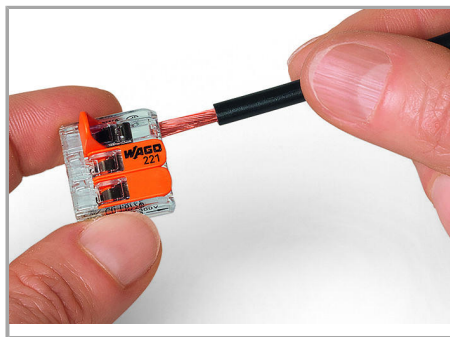

Termination: Lift the lever to open the clamping unit and insert a stripped conductor.

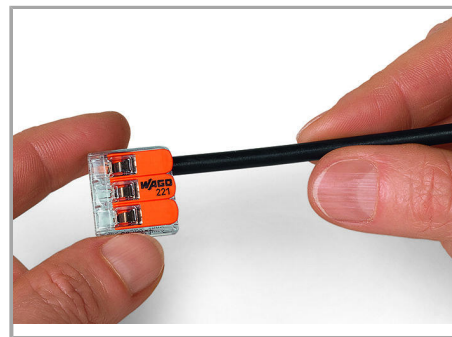

Then, lower the lever to close the clamp.

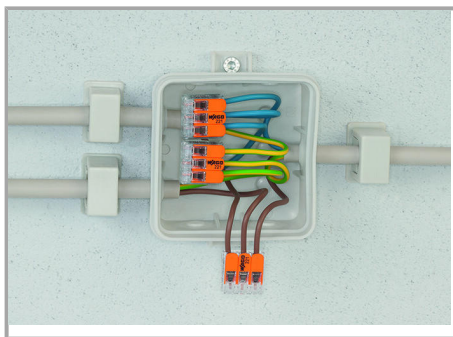

Wiring fine-stranded conductors in a junction box.

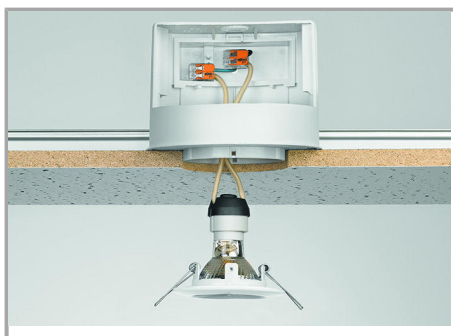

Custom low-voltage lighting system



Lighting distribution in ceiling canopy



Pendant light connection in suspended ceilings

Supus modificărilor.

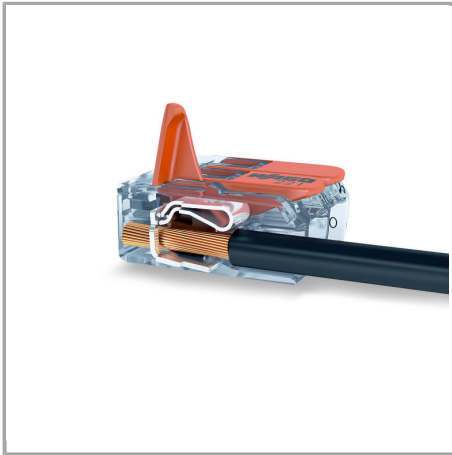

COMPACT Splicing Connectors for All  
Conductor Types, 4 mm<sup>2</sup> (12 AWG), 221  
Series

Supus modificărilor.