

Price

Lead time

Configuration

Type:	B
Size:	Q11
Input:	Metric
Output shaft/bore:	Standard ø42
Mounting:	FB
Mounting position:	B3
Input bore:	-
Coupling:	-

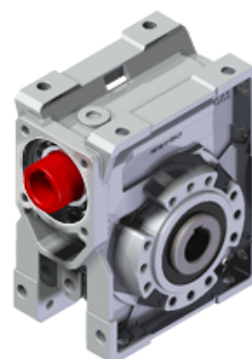

Technical data

Input rpm (n_1):	n.a. min⁻¹
Output rpm (n_2):	n.a. min⁻¹
Ratio (i):	45.00
Nominal power (P_{1R}):	2.70 kW
Nominal torque (M_{2R}):	599 Nm
Dynamic efficiency (RD):	73%

Selection

Motor power (P_{1M}):	n.a.
Output torque (M_{2M}):	n.a.
Service factor (f.s.):	n.a.

Lubrication

Oil quantity:	2.00l
AGIP:	Blasia 460

On our website

Features How to order Dimension Accessories/options Electric motors Selection guide - fs Mounting pos. - lubricant Calc. the overhung load	Irreversibility Thermal limit Atex certification Installation check list Spare parts list Complete catalogue Selection by power (xls)
---	---

Note

Direction of rotation

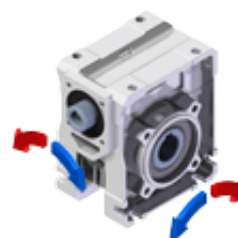

Axial and radial loads

Input shaft

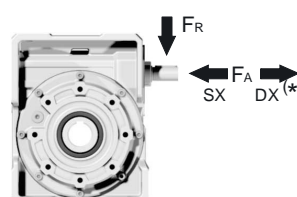

n_2 (min ⁻¹)	FA (N)	FR (N)
1400	228	1140

*Strong axial loads in the DX direction are not allowed

Output shaft

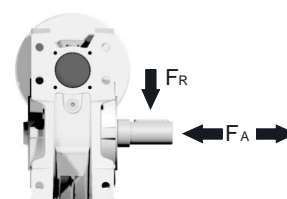

n_2 (min ⁻¹)	FA (N)	FR (N)
200	600	2900
150	700	3300
100	750	3600
75	800	4000
50	920	4600
25	1200	6000
15	1400	7000

Square - Gear
651Nm **Q11**

3D dimensions on the Web

PQ11**FB**... Basic wormbox
Riduttore base

Gearbox weight
peso riduttore **35.0 kg**

M. flanges	Kit code	øF	A
71B5	K023.4.041	160	136
80/90B5	K023.4.042	200	138
100/112B5	K023.4.043	250	147
132B5	-	300	187
80B14	K085.4.046	120	138
90B14	K085.4.045	140	138
100/112B14	K023.4.041	160	136
132B14	-	200	187

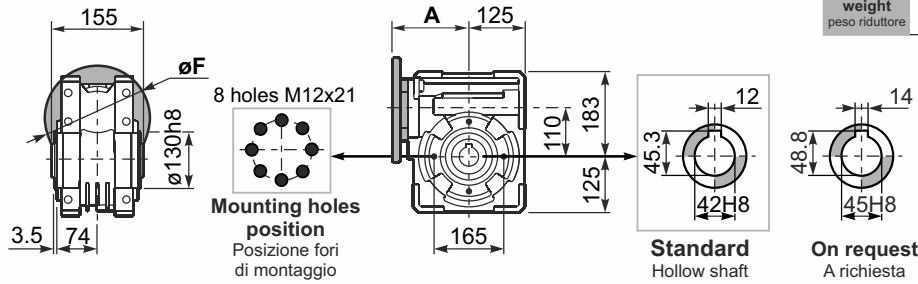

Standard
Hollow shaft

On request
A richiesta

2

PQ11**FC**... Output flange
Flangia uscita

PQ11**F1**... Output flange
Flangia uscita

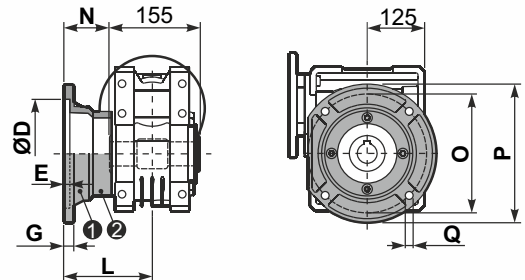
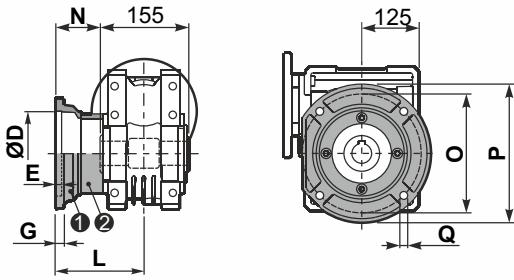

type B	øD	E	G	L	N	O	P	Q	kit code
FC	170 ^{+0.083} / _{+0.043}	11	16.5	131.5	54	230	270	13	1 K110.9.010 2 -
FL	170 ^{+0.083} / _{+0.043}	11	16.5	179.5	102	230	270	13	1 K110.9.011 2 -

type S	øD	E	G	L	N	O	P	Q	kit code
F1	180 ^{+0.040} / ₀	5	18	150	72.5	215	250	15	1 KS110.9.014 2 -
F2	170 ^{+0.083} / _{+0.043}	9.5	15	178	100.5	230	270	13	1 KS110.9.012 2 -
F3	180 ^{+0.040} / ₀	5	18	130	52.5	215	250	15	1 KS110.9.013 2 -

PQ11**FB**... Feet
Piedini

PQ11**BR**... Reaction arm
Braccio di reazione

kit cod. K110.9.027

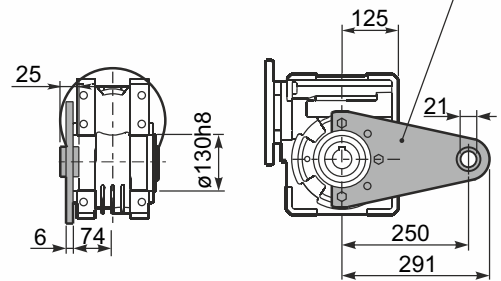
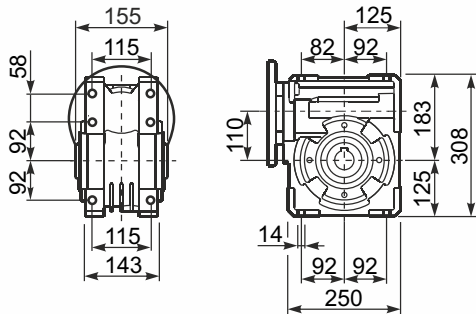

RQ11**FB**... Input shaft
Albero in entrata

PQ11.....**S**... Single Shaft
Albero lento semplice

PQ11.....**D**... Double Shaft
Albero lento bisp.

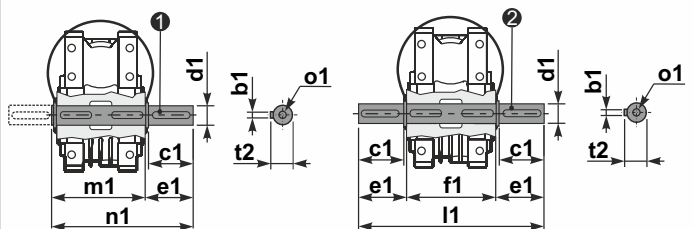
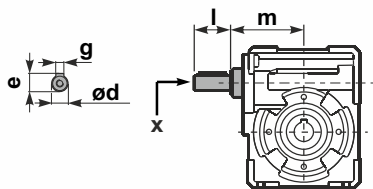

1 kit cod. K110.5.028 type B

2 kit cod. K110.5.029 type B

	ød	e	g	l	m	x	kit code
type B	25 h6	28	8	50	131.5	M8x20	1 K085.5.007 PAM90 2 K085.5.008 PAM100
type S	24 h6	27	8	50	131.5	M8x20	1 KS085.5.009 PAM90 2 KS085.5.011 PAM100

	b1	c1	d1	e1	f1	l1	m1	n1	t2	o1
type B	12	75	42 ^{-0.005} / _{-0.020}	96.5	155	348	163.5	260	45	M12x32
type S	-	-	-	-	-	-	-	-	-	-