

BQ75FB09C0-MB3-

Price

Lead time

Configuration

Type:	B
Size:	Q75
Input:	Metric
Output shaft/bore:	Standard ø30
Mounting:	FB
Mounting position:	B3
Input bore:	-
Coupling:	-

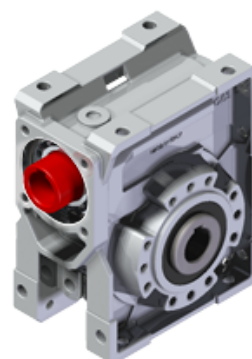

Technical data

Input rpm (n_1):	n.a. min⁻¹
Output rpm (n_2):	n.a. min⁻¹
Ratio (i):	60.00
Nominal power (P_{1R}):	0.75 kW
Nominal torque (M_{2R}):	200 Nm
Dynamic efficiency (RD):	65%

Selection

Motor power (P_{1M}):	n.a.
Output torque (M_{2M}):	n.a.
Service factor (f.s.):	n.a.

Lubrication

Oil quantity:	0.40l
AGIP:	Telium VSF 320
SHELL:	Omala S4 WE 320

On our website

Features	Irreversibility
How to order	Thermal limit
Dimension	Atex certification
Accessories/options	Installation check list
Electric motors	Spare parts list
Selection guide - fs	Complete catalogue
Mounting pos. - lubricant	Selection by power (xls)
Calc. the overhung load	

Direction of rotation

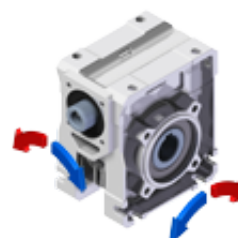

Note

Axial and radial loads

Input shaft

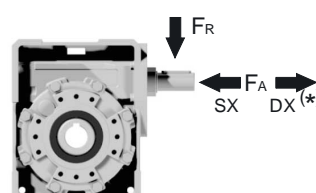

n_2 (min ⁻¹)	FA (N)	FR (N)
1400	125	630

*Strong axial loads in the DX direction are not allowed

Output shaft

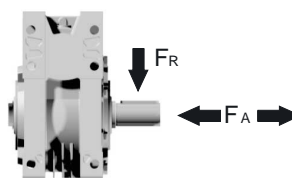

n_2 (min ⁻¹)	FA (N)	FR (N)
200	460	2300
150	520	2600
100	560	2800
75	620	3100
50	720	3600
25	880	4400
15	1000	5000

Square - Gear
270Nm **Q75**

3D dimensions on the Web

PQ75FB... Basic wormbox
Riduttore base

Gearbox weight
peso riduttore **8.70 kg**

M. flanges	Kit code	øF	A
71B5	K023.4.041	160	114
80/90B5	K023.4.042	200	116
100/112B5	K023.4.043	250	125
80B14	K085.4.046	120	116
90B14	K085.4.045	140	116
100/112B14	K085.4.047	160	125

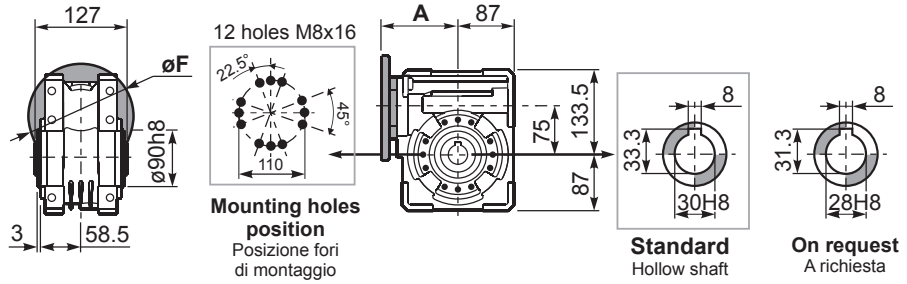

2

PQ75FC... Square flange
Flangia quadrata

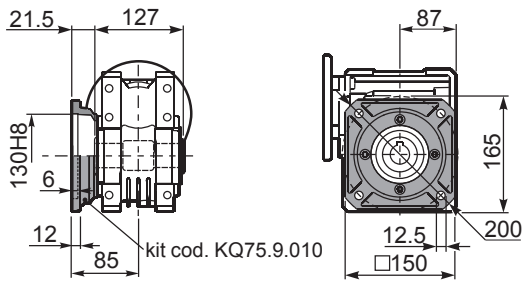

PQ75FL... Square flange
Flangia quadrata

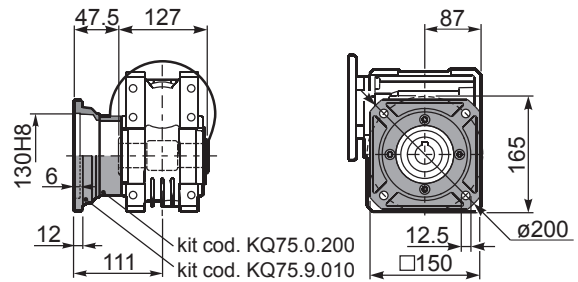

PQ75FB... Feet
Piedini

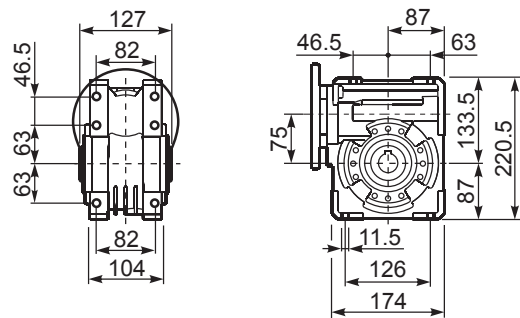

PQ75BR... Reaction arm
Braccio di reazione

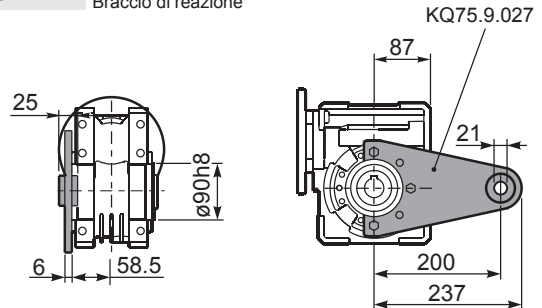

RQ75FB... Input shaft
Albero in entrata

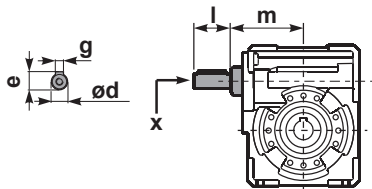

PQ75...S... Single Shaft
Albero lento semplice

PQ75...D... Double Shaft
Albero lento bisp.

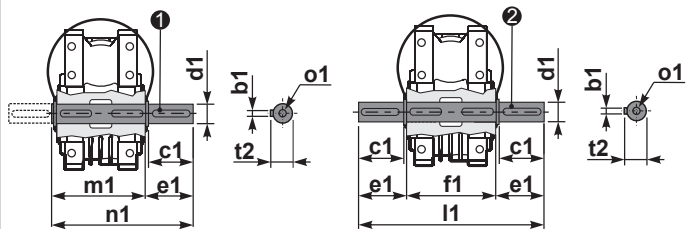

① kit cod. KQ75.5.028 Standard kit cod. KQ75.5.026 On request
② kit cod. KQ75.5.029 Standard kit cod. KQ75.5.027 On request

	ød	e	g	l	m	x	kit code
type B	25 h6	27.8	8	50	109.5	M8x20	KQ75.5.006 PAM80 K085.5.007 PAM90 K085.5.008 PAM100

	b1	c1	d1	e1	f1	l1	m1	n1	t2	o1
Standard	8	60	30 ^{-0.005/-0.020}	65	127	255	134	199	33	M8x20
On request	8	60	28 ^{-0.005/-0.020}	65	127	255	134	199	31	M8x20