

BQ85FB08C0-MB3-

Price

Lead time

Configuration

Type:	B
Size:	Q85
Input:	Metric
Output shaft/bore:	Standard ø35
Mounting:	FB
Mounting position:	B3
Input bore:	-
Coupling:	-

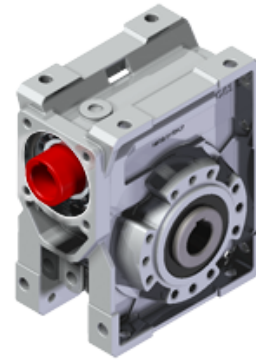

Technical data

Input rpm (n_1):	n.a. min⁻¹
Output rpm (n_2):	n.a. min⁻¹
Ratio (i):	46.00
Nominal power (P_{1R}):	1.50 kW / 2.47 HP
Nominal torque (M_{2R}):	326 Nm / 2744 lb in
Dynamic efficiency (RD):	68%

Selection

Motor power (P_{1M}):	n.a.
Output torque (M_{2M}):	n.a.
Service factor (f.s.):	n.a.

Lubrication

Oil quantity:	1.20l
AGIP:	Telium VSF 320
SHELL:	Omala S4 WE 320

On our website

Features How to order Dimension Accessories/options Electric motors Selection guide - fs Mounting pos. - lubricant Calc. the overhung load	Irreversibility Thermal limit Atex certification Installation check list Spare parts list Complete catalogue Selection by power (xls)
---	---

Note

Direction of rotation

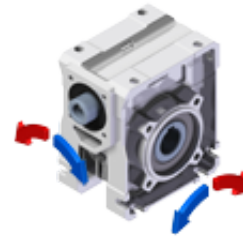

Axial and radial loads

Input shaft

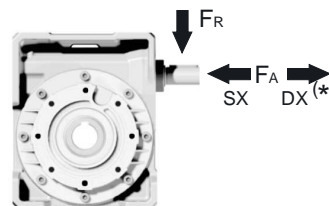

n_2 (min ⁻¹)	FA (N)	FR (N)
1400	160	809

*Strong axial loads in the DX direction are not allowed

Output shaft

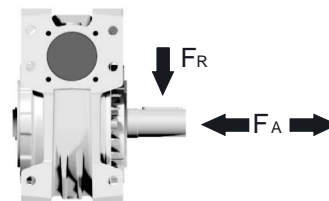

n_2 (min ⁻¹)	FA (N)	FR (N)
200	500	2500
150	580	2900
100	600	3000
75	700	3500
50	800	4000
25	1000	5000
15	1160	5800

Square - Gear
347Nm **Q85**

3D dimensions on the Web

PQ85**FB**... Basic wormbox
Riduttore base

Gearbox weight
peso riduttore **12.1 kg**

M. flanges	Kit code	øF	A
71B5	K023.4.041	160	116.5
80/90B5	K023.4.042	200	118.5
100/112B5	K023.4.043	250	127.5
80B14	K085.4.046	120	118.5
90B14	K085.4.045	140	118.5
100/112B14	K085.4.047	160	127.5

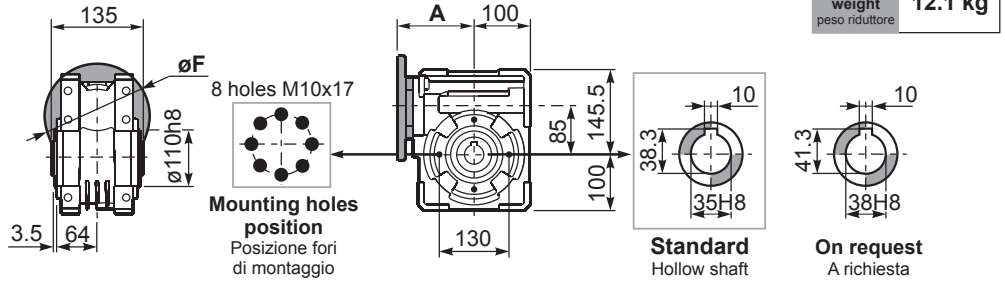

PQ85**FC**... Output flange
Flangia uscita

PQ85**F1**... Output flange
Flangia uscita

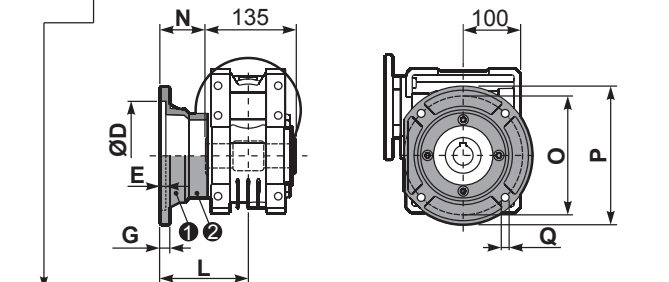
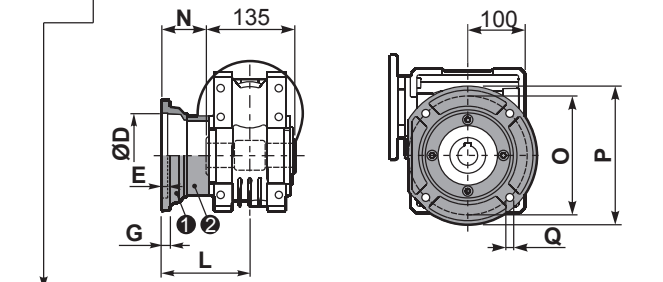

type B	øD	E	G	L	N	O	P	Q	kit code
FC	152 ^{+0.06} / _{+0.00}	5	16	108	40.5	176	205	13	① K085.9.010 ② -
FL	152 ^{+0.06} / _{+0.00}	5	16	148.5	81	176	205	13	① K085.9.010 ② K085.0.201

type S	øD	E	G	L	N	O	P	Q	kit code
F1	130 H7	5	13	117.5	50	165	200	11.5	① KS085.9.012 ② -
F2	152 ^{+0.06} / _{+0.00}	5	15	147.5	80	180	205	12.5	① KS085.9.013 ② -
F4	130 H7	5	13	106.5	39	165	200	13	① KS085.9.015 ② -

PQ85**FB**... Feet
Piedini

PQ85**BR**... Reaction arm
Braccio di reazione

kit cod. K085.9.027

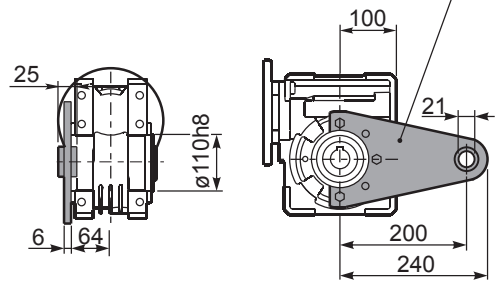
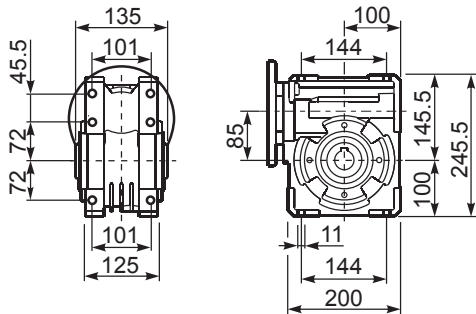

RQ85**FB**... Input shaft
Albero in entrata

PQ85.....**S**... Single Shaft
Albero lento semplice

PQ85.....**D**... Double Shaft
Albero lento bisp.

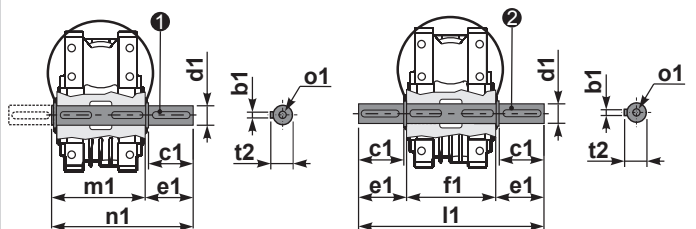
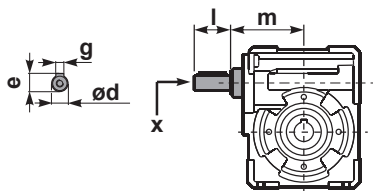

① kit cod. K085.5.028 type B

② kit cod. K085.5.029 type B

	ød	e	g	l	m	x	kit code
type B	25 h6	28	8	50	112	M8x20	① K085.5.007 PAM90 ② K085.5.008 PAM100
type S	24 h6	27	8	50	112	M8x20	① KS085.5.009 PAM90 ② KS085.5.011 PAM100

	b1	c1	d1	e1	f1	l1	m1	n1	t2	o1
type B	10	60	35 ^{-0.005} / _{+0.020}	73.5	135	282	141	214.5	38	M10x23
type S	-	-	-	-	-	-	-	-	-	-